

PRODUCT LIST



TWIN WALL FLUE

OIL & GAS

VITREOUS FLUE









VENTILATION

PELLET FLUE

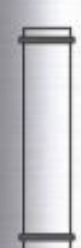
FLEXI 316L & 904L

STAINLESS STEEL FLUE

INDUSTRIAL FLUE

 <p>FLEXI LINERS</p>	 <p>TWIN WALL</p>	 <p>SINGLE WALL</p>	 <p>VITREOUS ENAMEL</p>
 <p>INDUSTRIAL FLUES</p>	 <p>HETAS</p>	 <p>VENTILATION</p>	 <p>INSTALLERS EQUIPMENT</p>

INSTALLER EQUIPMENT

DATA-PLATE/ 10 PACK (FOIL BACK)

10 FOIL BACK DATA PLATES FOR SOLID FUEL APPLIANCE INSTALLATION

-

COMPLIANCE BOOK CERTIF

TRIPPLICATE COMPLIANCE CERTIFICATE BOOK (50 OF PER BOOK)

-

WOOD/MOISTURE/METER/BUDGET

BUDGET WOOD MOISTURE METER

-

SMOKE PELLETS-100

13 GRAM SMOKE PELLETS (TUB 50) 40 SEC. BURN

-

DM2000

DRAUGHT GAUGE C/W S/S PROBE & RUBBER HOSE

-

CARBON MONOXIDE ALARM EI208

i-PHONE COMPATILE EI208

-

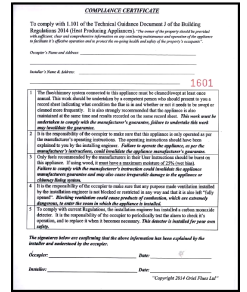
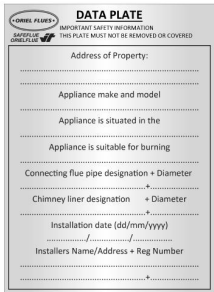

VENTILATION

WH = WHITE BS = BUFF SAND TC = TERRACOTTA

VENT/GRILL/1/BS/CWL

SUPER ACOUSTIC LOOK RYT AIRCORE- AAC125LPBCWL

7,200mm2

VENT/GRILL/1/TC/CWL

SUPER ACOUSTIC LOOK RYT AIRCORE- AAC125LPTCWL

7,200mm2

VENT/GRILL/1/WH/CWL

SUPER ACOUSTIC LOOK RYT AIRCORE- AAC125LPWCWL

7,200mm2

VENT/GRILL/2/BS/CWL

COWLED LOOKRYT AIRCORE VENT- AC10LPBCWL

11,100mm2

VENT/GRILL/2/BS/CWL

COWLED LOOKRYT AIRCORE VENT- AC10LPBCWL

11,100mm2

VENT/GRILL/2/TC/CWL

COWLED LOOKRYT AIRCORE VENT- AC10LPTCWL

11,100mm2

VENT/GRILL/3/TC/CWL

COWLED LOOKRYT AIRCORE VENT- AC7LPTCWL

8,100mm2

VENT/GRILL/3/TC/CWL

COWLED LOOKRYT AIRCORE VENT- AC7LPTCWL

8,100mm2

VENT/GRILL/3/WH/CWL

COWLED LOOKRYT AIRCORE VENT- AC7LPWCWL

8,100mm2

VENT/GRILL/4/BS

9' X 3' VENTILATION SET WITH LOUVERED VENTILATION

9,400mm2

VENT/GRILL/5/BS

150mm DIRECT VENTILATION KIT WITH LV120 LOUVRE GRILL-DVKIT150B

-

VENT/GRILL/5/TC

150mm DIRECT VENTILATION KIT WITH LV120 LOUVRE GRILL- DVKIT150T

-

VENT/GRILL/5/WH

150mm DIRECT VENTILATION KIT WITH LV120 LOUVRE GRILL- DVKIT150W

-

VENT/GRILL/6/BRASS

FLOOR VENTILATOR WITH BRASS LOUVRED

11,000mm/sq.

VENT/GRILL/7/BS

COWLED LOOKRYT AIRCORE VENT- AC3LPBSL

3,168mm2

VENT/GRILL/7/TC

COWLED LOOKRYT AIRCORE VENT -AC3LP TL

-

VENT/GRILL/7/WH

COWLED LOOKRYT AIRCORE VENT- AC3LPWL

-

VENT/GRILL/8/WH

100mm DIRECT VENTILATION KIT WITH LV120 LOUVRE GRILL- DVKIT100WH

-

* PRODUCT DESIGNATION APPLICABLE TO INDIVIDUAL ITEMS, PLEASE CHECK PRODUCT.



RYTONS
BUILDING PRODUCTS
INNOVATION IN VENTILATION



* PRODUCT DESIGNATION APPLICABLE TO INDIVIDUAL ITEMS, PLEASE CHECK PRODUCT.

PART No.

DESCRIPTION

Ø

MODINOX TWIN WALL LENGTHS



TWR/MF/153/1	950mm STRAIGHT PIPE T.W. (MULTIFUEL)	153
TWR/MF/153/2	450mm STRAIGHT PIPE T.W. (MULTIFUEL)	153
TWR/MF/153/3	250mm STRAIGHT PIPE T.W. (MULTIFUEL)	153
TWR/MF/153/4	100mm STRAIGHT PIPE T.W. (MULTIFUEL)	153
TWR/MF/153/5	450mm STRAIGHT PIPE (ADJ from 450-330)	153

Larger Diameters in 180mm, 200mm, 250mm & 300mm Available on Request.

MODINOX TWIN WALL TEE PIECE & PLUG



TWR/MF/153/10	45-TEE PIECE (C.W. TEE PLUG) T.W. (MULTIFUEL)	153
TWR/MF/153/9	90-TEE PIECE (C.W. TEE PLUG) T.W. (MULTIFUEL)	153

Larger Diameters in 180mm, 200mm, 250mm & 300mm Available on Request.

MODINOX TWIN WALL INSPECTION TEE



TWR/MF/153/39	INSPECTION TEE FOR 153mm T.W (MULTIFUEL)	153
---------------	--	-----

Larger Diameters in 180mm, 200mm, 250mm & 300mm Available on Request.

MODINOX TWIN WALL DRAUGHT STABILISER



TWR/MF/100/DRAUGHTSTABILISER	DRAUGHTSTABILISER 100 -140mm	100-140
TWR/MF/153/DRAUGHT STABILISER	DRAUGHT STABILISER 140- 200mm	140-200
TWR/MF/230/DRAUGHT STABILISER	DRAUGHT STABILISER 200-300mm	200-230

MODINOX TWIN WALL BENDS

90° Bends are suitable for Oil & Gas only



TWR/MF/153/6	15° BEND (1 PIECE) T.W. (MULTIFUEL)	153
TWR/MF/153/7	45° BEND (22.5° X 2) T.W. (MULTIFUEL)	153
TWR/MF/153/8	90° BEND (22.5° X 4) * T.W. (MULTIFUEL)	153
TWR/MF/153/18	22.5° BEND X 1 T.W. (MULTIFUEL)	153
TWR/MF/153/35	30° BEND (2 PIECE) T.W. (MULTIFUEL)	153

Larger Diameters in 180mm, 200mm, 250mm & 300mm Available on Request.

*PRODUCT DESIGNATION

TW 100mm - 130mm EN1856-1. T600-N1-D-Vm-L50060-G50 T600-N1-W-Vm-L50060-G50 TW 153mm - 250mm EN1856-1. T450-N1-D-Vm-L50040-G80 T250-P2-W-Vm-L50040-O20

MODINOX TWIN WALL ADAPTORS & COVER



TWR/MF/153/13	ADAPTOR FOR SINGLE WALL FLUE TW (MULTIFUEL)	153
TWR/MF/153/SP/3	SPECIAL ADAPTOR (6" TW to 5" SW)	125-153
TWR/MF/153/32	SINGLE WALL ADAPTOR COVERS (6" TW –6"SW)	153
TWR/MF/153/41	SPECIAL ADAPTOR COVER (6" TW to 5" SW)	125-153

Larger Diameters in 180mm, 200mm, 250mm & 300mm Available on Request.

MODINOX TWIN WALL LEAD & ALU. ROOF FLASHINGS

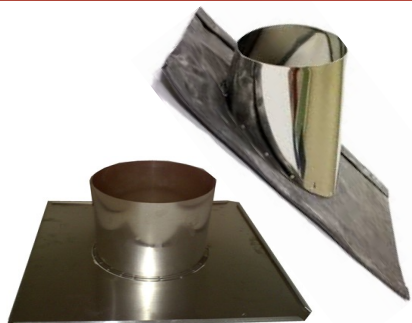

TWR/MF/153/17	ROOF LEAD FLASHING (15°- 30°)	153
TWR/MF/153/21	ROOF LEAD FLASHING (30°- 45°)	153
TWR/MF/153/23	ALU. ROOF FLASHING (90°) FLAT ROOF	153

Larger Diameters in 180mm, 200mm, 250mm & 300mm Available on Request.

MODINOX TWIN WALL STORM COLLAR



TWR/MF/153/26	STORM COLLAR T.W. (MULTIFUEL)	153
---------------	-------------------------------	-----

Larger Diameters in 180mm, 200mm, 250mm & 300mm Available on Request.

MODINOX TWIN WALL MASTER & MULTI ROOF FLASHING



TWR/MF/RS/33	MASTER FLASHING (76mm to 203mm)	-
TWR/MF/RS/34	MASTER FLASHING (203mm to 279mm)	-
TWR/MF/RS/35	MULTI FLASHING (88mm to 171mm)	-
TWR/MF/RS/36	MULTI FLASHING (165mm to 304mm)	-
TWR/MF/RS/38	MULTI FLASHING (230mm to 330mm)	-

MODINOX TWIN WALL FIRESTOP SQUARE & ROUND

For use with G500 & G80 Products



TWR/MF/153/20	FIRE STOP SQUARE T.W. (MULTIFUEL)	153
TWR/MF/153/RND	FIRE STOP ROUND T.W. (MULTIFUEL)	153

Larger Diameters in 180mm, 200mm, 250mm & 300mm Available on Request.

MODINOX T.W. FIRESTOP SQUARE/ROUND COVER PLATES

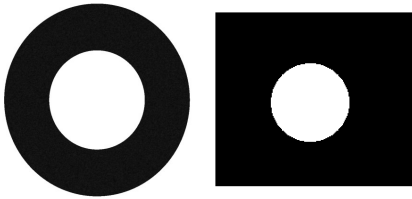

TWR/MF/153/RND-CO

COVER PLATE TO COVER 153mm ROUND

153

TWR/MF/153/20-CO

COVER PLATE TO COVER 153mm SQUARE

153

Larger Diameters in 180mm, 200mm, 250mm & 300mm Available on Request.

MODINOX TWIN WALL JOIST SUPPORT BRACKET



TWR/MF/153/14

SUPPORT COLLAR FOR JOISTS T.W. (MULTIFUEL)

153

Larger Diameters in 180mm, 200mm, 250mm & 300mm Available on Request.

MODINOX TWIN WALL BASEWALL SUPPORT



TWR/MF/153/15

BASE WALL SUPPORT T.W. (MULTIFUEL)

153

Larger Diameters in 180mm, 200mm, 250mm & 300mm Available on Request.

MODINOX TWIN WALL WATERPROOFING PLATE



TWR/MF/153/36

WATERPROOFING PLATE T.W. (MULTIFUEL)

153

Larger Diameters in 180mm, 200mm, 250mm & 300mm Available on Request.

MODINOX TWIN WALL ROSETTES



TWR/153/R/45

45° ROSETTE FOR 153mm T.W (4" LEAF)

153

TWR/153/R/90

90° ROSETTE FOR 153mm T.W (4" LEAF)

153

Alternative Diameters and Angles Available on Request.

MODINOX TWIN WALL 45° WALL SLEEVE

NOTE: SLEEVE CAN BE MODIFIED TO SUIT 90° OIL & GAS INSTALLATION

TWR/MF/153/38

45 DEGREE WALL SLEEVES T.W. (MULTIFUEL)

153



Larger Diameters in 180mm, 200mm, 250mm & 300mm Available on Request.

MODINOX TWIN WALL STANDARD WALL BRACKET

WALL BRACKETS ARE NOT LOAD BEARING LATERAL SUPPORT ONLY

TWR/MF/153/16

WALL BRACKETS FOR CHIMNEY T.W.

153



Larger Diameters in 180mm, 200mm, 250mm & 300mm Available on Request.

MODINOX TWIN WALL ADJUSTABLE BRACKET

ADJ/BRKT/153/TW

153mm TW ADJ. BRACKETS-MK (2PRT)

153



Larger Diameters in 180mm, 200mm, 250mm & 300mm Available on Request.

MODINOX TWIN WALL LOCKING BAND

LOCKING BANDS ARE SUPPLIED WITH EACH TWIN WALL ELEMENT

TWR/MF/153/27

LOCKING BAND FOR T.W

153



Larger Diameters in 180mm, 200mm, 250mm & 300mm Available on Request.

MODINOX TWIN WALL LOCATING BRACKET

GUY WIRE NOT INCLUDED

TWR/MF/153/22

LOCATING BRACKETS T.W. (MULTIFUEL)

153



Larger Diameters in 180mm, 200mm, 250mm & 300mm Available on Request.

MODINOX TWIN WALL CHIMNEY HAT



TWR/MF/153/12

CHIMNEY CAP T.W. (MULTIFUEL)

153

Larger Diameters in 180mm, 200mm, 250mm & 300mm Available on Request.

MODINOX TWIN WALL ANTI-DOWNDRAUGHT CHIMNEY HAT



TWR/MF/153/25

CHIMNEY CAP (Anti downdraught) T.W. (MULTIFUEL)

153

Larger Diameters in 180mm, 200mm, 250mm & 300mm Available on Request.

MODINOX TWIN WALL MITRON TERMINAL



TWR/MF/153/28

MITRON TERMINAL (PELLET & BIOMASS BOILERS)

153

Larger Diameters in 180mm, 200mm, 250mm & 300mm Available on Request.

MODINOX TWIN WALL H-COWL



TWR/MF/153/H-COWL

H - COWL T.W. (MULTIFUEL)

153

Larger Diameters in 180mm, 200mm, 250mm & 300mm Available on Request.

MODINOX TWIN WALL SPINNING COWL ADAPTOR



TWR/MF/153/37

SPINNING COWL ADAPTOR 153mm T.W. (MULTIFUEL)

153

Larger Diameters Available on Request.

CONVESA BLACK TWIN WALL LENGTHS



TWR/MF/153/CB-1	1000MM STRAIGHT PIPE T.W. MULTIFUEL	150
TWR/MF/153/CB-2	500MM STRAIGHT PIPE T.W. MULTIFUEL	150
TWR/MF/153/CB-3	250MM STRAIGHT PIPE T.W. MULTIFUEL	150
TWR/MF/153/CB-4	100MM STRAIGHT PIPE T.W. MULTIFUEL	150
TWR/MF/153/CB-5	500-350mm ADJUSTABLE PIPE T.W. MULTIFUEL	150

CONVESA BLACK TWIN WALL BENDS



TWR/MF/153/CB-35	30° BEND T.W. MULTIFUEL	150
TWR/MF/153/CB-6	15° BEND T.W. MULTIFUEL	150
TWR/MF/153/CB-7	45° BEND T.W. MULTIFUEL	150
TWR/MF/153/CB-8	90° BEND T.W. MULTIFUEL	150

CONVESA BLACK TWIN WALL TEE PIECE & PLUG



TWR/MF/153/CB-10	45° DEGREE TEE PIECE	150
TWR/MF/153/CB-9	90° DEGREE TEE PIECE	150
TWR/MF/153/CB-11	TEE PLUG	150
TWR/MF/153/CB-40	PLUG C/W CONDENSATE DRAIN	150

CONVESA BLACK TWIN WALL DRAUGHT STABILISER



TWR/MF/153/CB-DRAUGHTSTABILISER	DRAUGHT STABILISER T.W. MULTIFUEL	150
---------------------------------	-----------------------------------	-----

CONVESA BLACK TWIN WALL ADAPTOR



TWR/MF/153/CB-13	150mm T.W. 150mm S/W MULTIFUEL	150
TWR/MF/153/CB-SP/3	150mm T.W. TO 125mm S/W MULTIFUEL	150

CONVESA BLACK TWIN WALL FIRESTOP

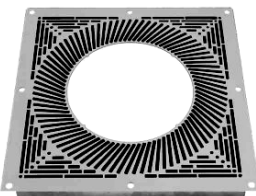

TWR/MF/153/CB-20	VENTILATED FIRESTOP WHITE T.W. MULTIFUEL	150
------------------	--	-----

CONVESA BLACK TWIN WALL ROSETTES



TWR/MF/153/CB-R-45	30-45 ADJUSTABLE SPLIT ROSSETTE T.W. MULTIFUEL	150
TWR/MF/153/CB-R-90	0-30 ADJUSTABLE SPLIT ROSSETTE T.W. MULTIFUEL	150

CONVESA BLACK TWIN WALL BASE SUPPORT

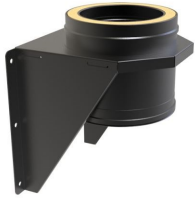

TWR/MF/153/CB-15

BASE SUPPORT T.W. MULTIFUEL

153

CONVESA BLACK TWIN WALL LEAD FLASHING & STORM COLLAR



TWR/MF/153/CB-17

20-45 DEGREE LEAD FLASHING T.W. MULTIFUEL

153

TWR/MF/153/CB-21

45-60 DEGREE LEAD FLASHING T.W. MULTIFUEL

153

TWR/MF/153/CB-26

STORM COLLAR T.W. MULTIFUEL

153

TWR/MF/153/CB-36

30-45° COVER PLATE S/S X 150MM T.W. MULTIFUEL

150

CONVESA BLACK TWIN WALL STANDARD WALL BRACKET



TWR/MF/153/CB-16

WALL BRACKET T.W. MULTIFUEL ADJ 50-80mm

153

TWR/MF/153/CB-16-EXT

WALL BRACKET T.W. MULTIFUEL ADJ 80-440mm

153

CONVESA BLACK TWIN WALL LOCATING BRACKET



TWR/MF/153/CB-22

LOCATING BRACKET T.W. MULTIFUEL

153

CONVESA BLACK TWIN WALL HAT / ANTI DOWN DRAUGHT HAT



TWR/MF/153/CB-12

RAIN CAP BLACK T.W. MULTIFUEL

153

TWR/MF/153/CB-25

ANTI DOWN DRAUGHT RAIN CAP BLACK T.W.

153

CONVESA BLACK TWIN WALL H-COWL



TWR/MF/153/CB- H-COWL

H-COWL T.W. MULTIFUEL

153

CONVESA BLACK TWIN WALL STRUCTURAL LOCKING BAND



TWR/MF/153/CB-48

STRUCTURAL LOCKING BAND T.W. MULTIFUEL

153

* PRODUCT DESIGNATION APPLICABLE TO INDIVIDUAL ITEMS, PLEASE CHECK PRODUCT.

PART No.

DESCRIPTION

Ø

CONVESA S/S TWIN WALL LENGTHS



TWR/MF/153/C-1	1000MM STRAIGHT PIPE T.W. MULTIFUEL	150
TWR/MF/153/C-2	500MM STRAIGHT PIPE T.W. MULTIFUEL	150
TWR/MF/153/C-3	250MM STRAIGHT PIPE T.W. MULTIFUEL	150
TWR/MF/153/C-4	100MM STRAIGHT PIPE T.W. MULTIFUEL	150
TWR/MF/153/C-5	500-350mm ADJUSTABLE PIPE T.W. MULTIFUEL	150

CONVESA S/S TWIN WALL BENDS

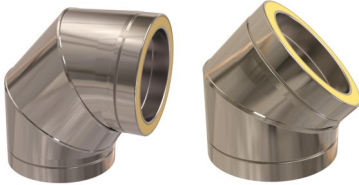

TWR/MF/153/C-35	30° BEND T.W. MULTIFUEL	150
TWR/MF/153/C-6	15° BEND T.W. MULTIFUEL	150
TWR/MF/153/C-7	45° BEND T.W. MULTIFUEL	150
TWR/MF/153/C-8	90° BEND T.W. MULTIFUEL	150

CONVESA S/S TWIN WALL TEE-PIECE & PLUG



TWR/MF/153/C-10	45° DEGREE TEE PIECE	153
TWR/MF/153/C-9	90° DEGREE TEE PIECE	153
TWR/MF/153/C-11	TEE PLUG	153
TWR/MF/153/C-40	PLUG C/W CONDENSATE DRAIN	153

CONVESA S/S TWIN WALL DRAUGHT STABILISER



TWR/MF/153/C-DRAUGHTSTABILISER	DRAUGHT STABILISER T.W. MULTIFUEL	150
--------------------------------	-----------------------------------	-----

CONVESA S/S TWIN WALL ADAPTOR



TWR/MF/153/C-13	150mm T.W. 150mm S/W MULTIFUEL	150
TWR/MF/153/C-SP/3	150mm T.W. TO 125mm S/W MULTIFUEL	150

CONVESA S/S TWIN WALL FIRESTOP—COVER PLATE

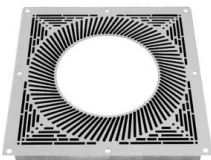

TWR/MF/153/C-20	VENTILATED FIRESTOP WHITE T.W. MULTIFUEL	150
TWR/MF/153/C-20-CO	VENTILATED FIRESTOP COVER PLATE WHITE T.W. MULTIFUEL	150

CONVESA S/S TWIN WALL ROSETTES



TWR/MF/153/C-R-45	30-45 ADJUSTABLE SPLIT ROSSETTE T.W. MULTIFUEL	150
TWR/MF/153/C-R-90	0-30 ADJUSTABLE SPLIT ROSSETTE T.W. MULTIFUEL	150

CONVESA S/S TWIN WALL JOIST SUPPORT



TWR/MF/153/C-14	JOIST SUPPORT T.W. MULTIFUEL	150
-----------------	------------------------------	-----

* PRODUCT DESIGNATION

EN1856-1 T600-N1-W-V2-L50040-G60

CONVESA S/S TWIN WALL BASEWALL SUPPORT



TWR/MF/153/C-15

BASE SUPPORT T.W. MULTIFUEL

150

CONVESA S/S TWIN WALL WALL SLEEVE



TWR/MF/153/C-38

WALL SLEEVE T.W. MULTIFUEL

150

CONVESA S/S TWIN WALL LEAD FLASHING & STORM COLLAR



TWR/MF/153/C-17

20-45° LEAD FLASHING T.W. MULTIFUEL

150

TWR/MF/153/C-21

45-60° LEAD FLASHING T.W. MULTIFUEL

150

TWR/MF/153/C-26

STORM COLLAR T.W. MULTIFUEL

150

TWR/MF/153/C-36

30-45° COVER PLATE S/S X 150MM T.W. MULTIFUEL

150

CONVESA S/S TWIN WALL STANDARD BRACKET



TWR/MF/153/C-16

WALL BRACKET ADJ 50-80mm T.W. MULTIFUEL

150

TWR/MF/153/C-16-EXT

WALL BRACKET ADJ 80-440mm T.W. MULTIFUEL

150

CONVESA S/S TWIN WALL LOCATING BRACKET



TWR/MF/153/C-22

LOCATING BRACKET T.W. MULTIFUEL

150

CONVESA S/S TWIN WALL HAT & ANTI-DOWN DRAUGHT HAT



TWR/MF/153/C-12

RAIN CAP C/W LOCKING BAND T.W. MULTIFUEL

150

TWR/MF/153/C-25

ANTI DOWN DRAUGHT RAIN CAP T.W. MULTIFUEL

150

CONVESA S/S TWIN WALL H-COWL



TWR/MF/153/C- H-COWL

H-COWL T.W. MULTIFUEL

150

CONVESA S/S TWIN WALL JOIST SUPPORT



TWR/MF/153/C-48

STRUCTURAL LOCKING BAND T.W. MULTIFUEL

150

PELLET TWIN WALL LENGTHS



TWR/MF/80/P-1	1000mm STRAIGHT PIPE T.W. (PELLET)	80
TWR/MF/80/P-2	500mm STRAIGHT PIPE T.W. (PELLET)	80
TWR/MF/80/P-3	250mm STRAIGHT PIPE T.W. (PELLET)	80
TWR/MF/80/P-5	500mm STRAIGHT PIPE (ADJ from 500-380)	80
TWR/MF/100/P-1	1000mm STRAIGHT PIPE T.W. (PELLET)	100
TWR/MF/100/P-2	500mm STRAIGHT PIPE T.W. (PELLET)	100
TWR/MF/100/P-3	250mm STRAIGHT PIPE T.W. (PELLET)	100
TWR/MF/100/P-5	500mm STRAIGHT PIPE (ADJ from 500-380)	100
TWR/MF/130/P-1	1000mm STRAIGHT PIPE T.W. (PELLET)	130
TWR/MF/130/P-2	450mm STRAIGHT PIPE T.W. (PELLET)	130
TWR/MF/130/P-3	250mm STRAIGHT PIPE T.W. (PELLET)	130
TWR/MF/130/P-5	450mm STRAIGHT PIPE (ADJ from 450-330)	130

PELLET TWIN WALL BENDS

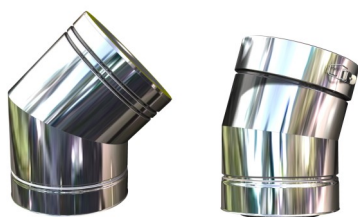

TWR/MF/80/P-6	15° BEND (1 Piece) T.W. (PELLET)	80
TWR/MF/80/P-35	30° BEND (1 Piece) T.W. (PELLET)	80
TWR/MF/100/P-6	15° BEND (1 Piece) T.W. (PELLET)	100
TWR/MF/100/P-35	30° BEND (1 Piece) T.W. (PELLET)	100
TWR/MF/130/P-6	15° BEND (1 Piece) T.W. (PELLET)	130
TWR/MF/130/P-35	30° BEND (1 Piece) T.W. (PELLET)	130
TWR/MF/80/P-7	45° BEND (1 Piece) T.W. (PELLET)	80
TWR/MF/100/P-7	45° BEND (1 Piece) T.W. (PELLET)	100
TWR/MF/130/P-7	45° BEND (1 Piece) T.W. (PELLET)	130

PELLET TWIN WALL TEE PIECE & PLUG



TWR/MF/80/P-10	45° TEE PIECE (C.W. TEE PLUG) T.W.(PELLET)	80
TWR/MF/100/P-10	45° TEE PIECE (C.W. TEE PLUG) T.W.(PELLET)	100
TWR/MF/130/P-10	45° TEE PIECE (C.W. TEE PLUG) T.W.(PELLET)	130
TWR/MF/80/P-9	90° TEE PIECE (C.W. TEE PLUG) T.W.(PELLET)	80
TWR/MF/100/P-9	90° TEE PIECE (C.W. TEE PLUG) T.W.(PELLET)	100
TWR/MF/130/P-9	90° TEE PIECE (C.W. TEE PLUG) T.W.(PELLET)	130

PELLET TWIN WALL ADAPTOR



TWR/MF/80/P-13-FEMALE	ADAPTOR FOR S.W. FLUE T.W. (PELLET)	80
TWR/MF/100/P-13-FEMALE	ADAPTOR FOR S.W. FLUE T.W. (PELLET)	100
TWR/MF/130/P-13-FEMALE	ADAPTOR FOR S.W. FLUE T.W. (PELLET)	130

PELLET TWIN WALL BASEWALL SUPPORT & WATERPROOFING PLATE



TWR/MF/80/P-15	BASE WALL SUPPORT T.W. (PELLET)	80
TWR/MF/100/P-15	BASE WALL SUPPORT T.W. (PELLET)	100
TWR/MF/130/P-15	BASE WALL SUPPORT T.W. (PELLET)	130
TWR/MF/80/P-36	WATERPROOFING PLATE T.W. (PELLET)	80
TWR/MF/100/P-36	WATERPROOFING PLATE T.W. (PELLET)	100
TWR/MF/130/P-36	WATERPROOFING PLATE T.W. (PELLET)	130

PELLET TWIN WALL WALL SLEEVE

SLEEVE CAN BE MODIFIED TO SUIT 90 DEGREE OIL & GAS INSTALLATION

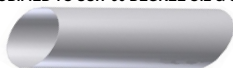

TWR/MF/80/P-38	45 DEGREE WALL SLEEVES T.W. (PELLET)	80
TWR/MF/100/P-38	45 DEGREE WALL SLEEVES T.W. (PELLET)	100
TWR/MF/130/P-38	45 DEGREE WALL SLEEVES T.W. (PELLET)	130

PELLET TWIN WALL ROSETTES



TWR/80/R/P-45	45° ROSETTE FOR 100mm T.W (4" LEAF)	80
TWR/80/R/P-90	90° ROSETTE FOR 100mm T.W (4" LEAF)	80
TWR/100/R/P-45	45° ROSETTE FOR 130mm T.W (4" LEAF)	100
TWR/100/R/P-90	90° ROSETTE FOR 130mm T.W (4" LEAF)	100
TWR/130/R/P-45	45° ROSETTE FOR 153mm T.W (4" LEAF)	130
TWR/130/R/P-90	90° ROSETTE FOR 153mm T.W (4" LEAF)	130

PELLET TWIN WALL FIRESTOP & COVER PLATE

For use with G50 & G80 Products



TWR/MF/80/P-20	FIRE STOP SQUARE T.W. (PELLET)	80
TWR/MF/100/P-20	FIRE STOP SQUARE T.W. (PELLET)	100
TWR/MF/130/P-20	FIRE STOP SQUARE T.W. (PELLET)	130
TWR/MF/80/P-RND	FIRE STOP ROUND T.W. (PELLET)	80
TWR/MF/100/P-RND	FIRE STOP ROUND T.W. (PELLET)	100
TWR/MF/130/P-RND	FIRE STOP ROUND T.W. (PELLET)	130
TWR/MF/80/P-RND-CO	COVER PLATE TO COVER 80mm ROUND	80
TWR/MF/100/P-RND-CO	COVER PLATE TO COVER 100mm ROUND	100
TWR/MF/130/P-RND-CO	COVER PLATE TO COVER 130mm ROUND	130
TWR/MF/80/P-20-CO	COVER PLATE TO COVER 80mm SQUARE	80
TWR/MF/100/P-20-CO	COVER PLATE TO COVER 100mm SQUARE	100
TWR/MF/130/P-20-CO	COVER PLATE TO COVER 130mm SQUARE	130

PELLET TWIN WALL MASTER & MULTI ROOF FLASHING



TWR/MF/RS/33	MASTER FLASHING (76mm to 203mm)	-
TWR/MF/RS/35	MULTI FLASHING (88mm to 171mm)	-
TWR/MF/RS/36	MULTI FLASHING (165mm to 304mm)	-
TWR/MF/100/P-23	ALU. ROOF FLASHING (90°) FLAT ROOF	-
TWR/MF/130/P-23	ALU. ROOF FLASHING (90°) FLAT ROOF	-
TWR/MF/130/P-17	ROOF LEAD FLASHING 15°-30°	-
TWR/MF/130/P-17-COVER	ROOF LEAD FLASHING 15°-30° COVER	-
TWR/MF/130/P-21	ROOF LEAD FLASHING 30°-45°	-
TWR/MF/130/P-21-COVER	ROOF LEAD FLASHING 30°-45° COVER	-

PELLET TWIN WALL STORM COLLAR

T450N1dvmL50040G

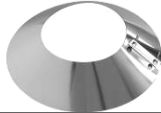

TWR/MF/80/P-26	STORM COLLAR T.W. (PELLET)	80
TWR/MF/100/P-26	STORM COLLAR T.W. (PELLET)	100
TWR/MF/130/P-26	STORM COLLAR T.W. (PELLET)	130

PELLET TWIN WALL HAT/ANTI-DOWNDRAUGHT HAT/MITRON TERMINAL



TWR/MF/80/P-12	CHIMNEY CAP T.W. (PELLET)	80
TWR/MF/100/P-12	CHIMNEY CAP T.W. (PELLET)	100
TWR/MF/130/P-12	CHIMNEY CAP T.W. (PELLET)	130
TWR/MF/80/P-25	CHIMNEY CAP (Anti downdraught) T.W. (PELLET)	80
TWR/MF/100/P-25	CHIMNEY CAP (Anti downdraught) T.W. (PELLET)	100
TWR/MF/130/P-25	CHIMNEY CAP (Anti downdraught) T.W. (PELLET)	130
TWR/MF/80/P-28	MITRON TERMINAL (PELLET & BIOMASS)	80
TWR/MF/100/P-28	MITRON TERMINAL (PELLET & BIOMASS)	100
TWR/MF/130/P-28	MITRON TERMINAL (PELLET & BIOMASS)	130

PELLET TWIN WALL BRACKETS



TWR/MF/80/P-16	WALL BRACKETS FOR CHIMNEY T.W. (PELLET)	80
TWR/MF/100/P-16	WALL BRACKETS FOR CHIMNEY T.W. (PELLET)	100
TWR/MF/130/P-16	WALL BRACKETS FOR CHIMNEY T.W. (PELLET)	130
ADJ/BRKT/80/P-TW	80mm TW ADJUSTABLE BRACKETS	80
ADJ/BRKT/100/P-TW	100mm TW ADJUSTABLE BRACKETS	100
ADJ/BRKT/130/P-TW	130mm TW ADJUSTABLE BRACKETS	130
TWR/MF/80/P-22	LOCATING BRACKETS FOR 80mm T.W. (PELLET)	80
TWR/MF/100/P-22	LOCATING BRACKETS FOR 100mm T.W. (PELLET)	100
TWR/MF/130/P-22	LOCATING BRACKETS FOR 130mm T.W. (PELLET)	130
TWR/MF/80/P-27	LOCKING BAND FOR 80mm T.W. (PELLET)	80
TWR/MF/100/P-27	LOCKING BAND FOR 100mm T.W. (PELLET)	100
TWR/MF/130/P-27	LOCKING BAND FOR 130mm T.W. (PELLET)	130

PELLET TWIN WALL JOIST SUPPORT BRACKET

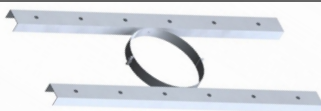

TWR/MF/80/P-14	SUPPORT COLLAR FOR JOISTS T.W. (PELLET)	80
TWR/MF/100/P-14	SUPPORT COLLAR FOR JOISTS T.W. (PELLET)	100
TWR/MF/130/P-14	SUPPORT COLLAR FOR JOISTS T.W. (PELLET)	130

* PRODUCT DESIGNATION APPLICABLE TO INDIVIDUAL ITEMS, PLEASE CHECK PRODUCT.

PELLET SINGLE WALL LENGTHS (MATT BLACK)



PART No.	DESCRIPTION	Ø
PN800	1000mm STRAIGHT PIPE	80
PN801	500mm STRAIGHT PIPE	80
PN801-DOOR	500mm STRAIGHT PIPE- INSPECTION DOOR	80
PN806	250mm TELESCOPIC TUBE/SLEEVE	80
PN802	250mm STRAIGHT PIPE	80
PN1000	1000mm STRAIGHT PIPE	100
PN1001	500mm STRAIGHT PIPE	100
PN1001-DOOR	500mm STRAIGHT PIPE- INSPECTION DOOR	100
PN1006	250mm TELESCOPIC TUBE/SLEEVE	100
PN1002	250mm STRAIGHT PIPE	100

PELLET SINGLE WALL BENDS



PN804	45° BEND	80
PN804-DOOR	45° BEND –DOOR	80
PN1004	45° BEND	100
PN1004-DOOR	45° BEND –DOOR	100
PN803	90° BEND M/F	80
PN803M	90° BEND M/M	80
PN808	90° BEND WITH DOOR	80
PN1003	90° BEND M/F	100
PN1003M	90° BEND M/M	100
PN1008	90° BEND M/F WITH DOOR	100

PELLET SINGLE WALL TEE PIECE / PLUGS / GASKETS



PN805F	90° TEE F/F	80
PN1005F	90° TEE F/F	100
PN818	ASH COLL. C/W BRASS COUPLING (MB)	80
PN819	ASH COLL. C/W SILICONE PLUG	80
PN1018	ASH COLL. C/W BRASS COUPLING (MB)	100
PN1019	ASH COLL. C/W SILICONE PLUG	100
AS819V	VITON GASKET (300°C)	80
AS1019V	VITON GASKET (300°C)	100

PELLET SINGLE WALL BRACKETS / TERMINALS / ROSETTE



PN821	WALL BRACKET	80
PN1021	WALL BRACKET	100
AL824	EXHAUST TERMINAL FITTING	80
AL1024	EXHAUST TERMINAL FITTING	100
PN810	ROSETTE	80
PN1010	ROSETTE	100

PELLET SINGLE WALL REDUCERS & FITTINGS



PN8/10	REDUCERS 100MM (FEMALE END) TO 80MM (MALE END)	80/100
PN10/8	REDUCERS 100MM (MALE END) TO 80MM (FEMALE END)	100/80
PN817F	FEMALE TO FEMALE FITTING	80
PN1017F	FEMALE TO FEMALE FITTING	100
PN817M	MALE TO FEMALE FITTING	80
PN1017M	MALE TO FEMALE FITTING	100

*PRODUCT DESIGNATION

EN:1856-2 T200-P1-W-V2-L01120-G240 (WOOD) T200-P1-W-V2-L01120-O40(GAS) T200-P1-W-V2-L01120-O10(GAS) T200-N1-W-V2-L01120-G240 T300-P1-W-V2-L01120-O4 T300-N1-W-V2-L01120-G240



VITREOUS ENAMEL SINGLE WALL LENGTHS Ø (MATT/GLOSS BLACK)



PART No.	DESCRIPTION	Ø
OF-125-1000-**	1000mm STRAIGHT PIPE	125
OF-125-500-**	500mm STRAIGHT PIPE	125
OF-125-500-**-ADJ	500mm STRAIGHT PIPE ADJ from 550-850	125
OF-125-250-**	250mm STRAIGHT PIPE	125
OF-150-1000-**	1000mm STRAIGHT PIPE	150
OF-150-500-**	500mm STRAIGHT PIPE	150
OF-150-500-**-ADJ	500mm STRAIGHT PIPE ADJ from 550-850	150
OF-150-250-**	250mm STRAIGHT PIPE	150

Lengths in 100mm, 175mm & 200mm diameters Available on Request.

VITREOUS ENAMEL SINGLE WALL LENGTHS - WITH DOOR



OF-125-1000-D-**	1000mm STRAIGHT PIPE WITH DOOR	125
OF-125-500-D-**	500mm STRAIGHT PIPE WITH DOOR	125
OF-125-250-D-**	250mm STRAIGHT PIPE WITH DOOR	125
OF-150-1000-D-**	1000mm STRAIGHT PIPE WITH DOOR	150
OF-150-500-D-**	500mm STRAIGHT PIPE WITH DOOR	150
OF-150-250-D-**	250mm STRAIGHT PIPE WITH DOOR	150

Lengths in 100mm, 175mm & 200mm diameters Available on Request.

VITREOUS ENAMEL SINGLE WALL LENGTHS DAMPER & Baffle PLATE INSERT



OF-125-250-**-DAMP.	250mm X 125mm MATT BLACK C/W DAMPER	125
OF-150-250-**-DAMP.	250mm X 150mm MATT BLACK C/W DAMPER	150
OF-125-DAMP	250X125 C/W DAMPER	125
OF-150-DAMP	250X150 C/W DAMPER	150

VITREOUS ENAMEL SINGLE WALL DOORS



OF-125-D-VE-**	VITREOUS ENAMEL DOOR	125
OF-150-D-VE-**	VITREOUS ENAMEL DOOR	150

VITREOUS ENAMEL COLOUR CHOICE

**Vitreous Enamel
Colour Choice**

**
**

**MATT BLACK
GLOSS BLACK**

**OF-100-1000-MB
*** -GB**

VITREOUS ENAMEL SINGLE WALL BENDS

(MATT BLACK)



OF-125-45-**-**	45° BEND	125
OF-150-45-**-**	45° BEND	150
OF-125-90-**-**	90° BEND (OIL & GAS ONLY)	125
OF-150-90-**-**	90° BEND (OIL & GAS ONLY)	150

110 Degree bends in 5" & 6" diameters Available on Request.

VITREOUS ENAMEL SINGLE WALL BENDS WITH DOORS



OF-125-45-D-**-**	45° BEND WITH DOOR	125
OF-150-45-D-**-**	45° BEND WITH DOOR	150
OF-125-90-D-**-**	90° BEND WITH DOOR (OIL & GAS ONLY)	125
OF-150-90-D-**-**	90° BEND WITH DOOR (OIL & GAS ONLY)	150

110 Degree bends with doors in 5" & 6" diameters Available on Request.

VITREOUS ENAMEL SINGLE WALL TEE PIECE & PLUG



OF-125-45-T-**-**	45° TEE WITH END CAP	125
OF-150-45-T-**-**	45° TEE WITH END CAP	150
OF-125-90-T-**-**	90° TEE WITH END CAP	125
OF-150-90-T-**-**	90° TEE WITH END CAP	150

VITREOUS ENAMEL SINGLE WALL INCREASER



OF-100-125-INC-**-**	INCREASER (100mm-125mm)	100
OF-125-150-INC-**-**	INCREASER (125mm-150mm)	125

VITREOUS ENAMEL SINGLE WALL ROSETTE



OF-125-R-MB	ROSETTE	125
OF-150-R-MB	ROSETTE	150

VITREOUS ENAMEL SINGLE WALL SPLIT ROSETTE



OF-125-ROS-S-MB	ROSETTE SPLIT	125
OF-150-ROS-S-MB	ROSETTE SPLIT	150

ORIVIT SINGLE WALL VITREOUS ENAMEL LENGTHS

(MATT BLACK)

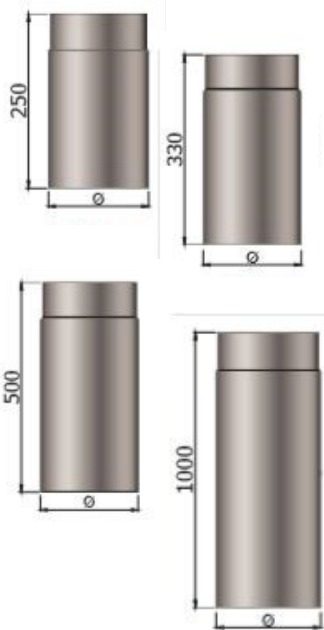

ORIVIT-125-1000-D-MB	PIPE 1000mm LENGTH C/W DOOR	125
ORIVIT-125-1000-MB	PIPE 1000mm LENGTH	125
ORIVIT-125-1200-MB	PIPE 1200mm LENGTH	125
ORIVIT-125-250-DAMP-MB	PIPE 250mm LENGTH C/W DAMPER	125
ORIVIT-125-250-MB	PIPE 250mm LENGTH	125
ORIVIT-125-330-D-MB	PIPE 330mm LENGTH C/W DOOR	125
ORIVIT-125-500-ADJ-MB	PIPE 500mm LENGTH ADJ. LENGTH	125
ORIVIT-125-500-D-MB	PIPE 500mm LENGTH C/W DOOR	125
ORIVIT-125-500-MB	PIPE 500mm LENGTH	125
ORIVIT-150-1000-D-MB	PIPE 1000mm LENGTH C/W DOOR	150
ORIVIT-150-1000-MB	PIPE 1000mm LENGTH	150
ORIVIT-150-1200-MB	PIPE 1200mm LENGTH	150
ORIVIT-150-250-DAMP-MB	PIPE 250mm LENGTH C/W DAMPER	150
ORIVIT-150-330-D-MB	PIPE 330mm LENGTH C/W DOOR	150
ORIVIT-150-250-MB	PIPE 250mm LENGTH	150
ORIVIT-150-500-ADJ-MB	PIPE 500mm LENGTH ADJ. LENGTH	150
ORIVIT-150-500-D-MB	PIPE 500mm LENGTH C/W DOOR	150
ORIVIT-150-500-MB	PIPE 500mm LENGTH	150

ORIVIT SINGLE WALL VITREOUS ENAMEL TEE PIECE & PLUG

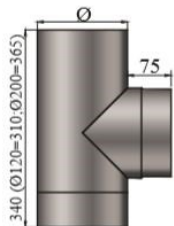

ORIVIT-125-45-T-MB	45 TEE C/W CAP	100
ORIVIT-125-90-T-MB	90 TEE C/W CAP	100
ORIVIT-150-45-T-MB	45 TEE C/W CAP	100
ORIVIT-150-90-T-MB	90 TEE C/W CAP	150

ORIVIT SINGLE WALL VITREOUS ENAMEL ADAPTOR

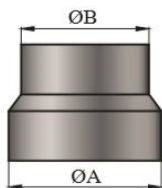

ORIVIT-150-122-MB	ADAPTER/ REDUCER 150mm F-M 122mm O.D	150
-------------------	--------------------------------------	-----

ORIVIT SINGLE WALL VITREOUS ENAMEL DAMPER



ORIVIT-125-250-DAMP	PIPE 250mm LENGTH C/W DAMPER	125
ORIVIT-150-250-DAMP	PIPE 250mm LENGTH C/W DAMPER	150
ORIVIT-125-DAMP	FLUE DAMPER FOR 125mm FLUE..	125
ORIVIT-150-DAMP	FLUE DAMPER FOR 150mm FLUE..	150

ORIVIT SINGLE WALL VITREOUS ENAMEL ELBOWS

(MATT BLACK)

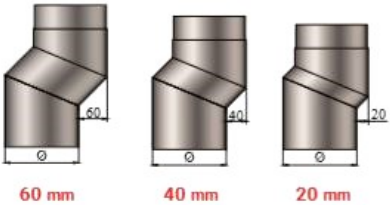
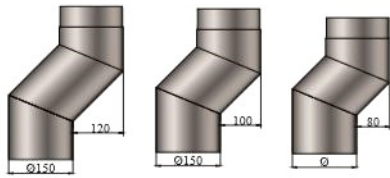

ORIVIT-125-OS-100-MB	S ELBOW BEND OFFSET (100mm) ADJ.	125
ORIVIT-125-OS-120-MB	S ELBOW BEND OFFSET (120mm) ADJ.	125
ORIVIT-125-OS-20-MB	S ELBOW BEND OFFSET (20mm) ADJ.	125
ORIVIT-125-OS-40-MB	S ELBOW BEND OFFSET (40mm) ADJ.	125
ORIVIT-125-OS-60-MB	S ELBOW BEND OFFSET (60mm) ADJ.	125
ORIVIT-125-OS-80-MB	S ELBOW BEND OFFSET (80mm) ADJ.	125
ORIVIT-150-OS-100-MB	S ELBOW BEND OFFSET (100mm) ADJ.	150
ORIVIT-150-OS-120-MB	S ELBOW BEND OFFSET (120mm) ADJ.	150
ORIVIT-150-OS-20-MB	S ELBOW BEND OFFSET (20mm) ADJ.	150
ORIVIT-150-OS-40-MB	S ELBOW BEND OFFSET (40mm) ADJ.	150
ORIVIT-150-OS-60-MB	S ELBOW BEND OFFSET (60mm) ADJ.	150
ORIVIT-150-OS-80-MB	S ELBOW BEND OFFSET (80mm) ADJ.	150

ORIVIT SINGLE WALL VITREOUS ENAMEL BENDS

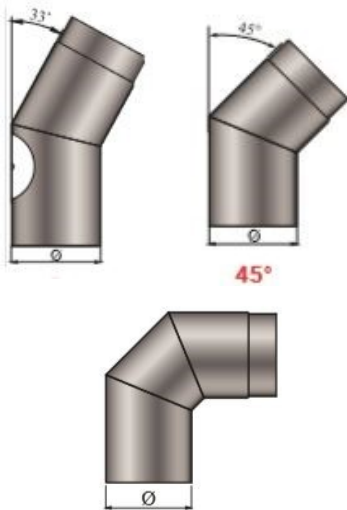

ORIVIT-125-0/90-ADJ	0-90 BEND INTERCHANGEABLE	125
ORIVIT-125-90-D-MB	ELBOW 90 PLAIN C/W DOOR	125
ORIVIT-125-90-MB	ELBOW 90 PLAIN	125
ORIVIT-125-33-MB	ELBOW 33 PLAIN	125
ORIVIT-125-45-D-MB	ELBOW 45 PLAIN C/W DOOR	125
ORIVIT-125-45-MB	ELBOW 45 PLAIN	125
ORIVIT-150-0/90-ADJ	0-90 BEND INTERCHANGEABLE	150
ORIVIT-150-90-D-MB	ELBOW 90 PLAIN C/W DOOR	150
ORIVIT-150-90-MB	ELBOW 90 PLAIN	150
ORIVIT-150-33-MB	ELBOW 33 PLAIN	150
ORIVIT-150-45-D-MB	ELBOW 45 PLAIN C/W DOOR	150
ORIVIT-150-45-MB	ELBOW 45 PLAIN	150

YOUR NUMBER ONE INSTALLATION PARTNER



CALL US TODAY FOR ADVICE & QUOTATIONS 041 685 6924

STAINLESS STEEL LENGTHS



SWR/SF/153/1	1000mm STRAIGHT PIPE s.w. (MULTIFUEL)	153
SWR/SF/153/2	670 mm STRAIGHT PIPE s.w. (MULTIFUEL)	153
SWR/SF/153/3	330mm STRAIGHT PIPE s.w. (MULTIFUEL)	153
SWR/SF/153/30	590-420 ADJ. STRAIGHT PIPE s.w. (MULTIFUEL)	153
SWR/SF/180/1	1000mm STRAIGHT PIPE s.w. (MULTIFUEL)	180
SWR/SF/180/2	670mm STRAIGHT PIPE s.w. (MULTIFUEL)	180
SWR/SF/180/3	330mm STRAIGHT PIPE s.w. (MULTIFUEL)	180
SWR/SF/180/30	590-420 ADJ STRAIGHT PIPE s.w. (MULTIFUEL)	180
SWR/SF/200/1	1000mm STRAIGHT PIPE s.w. (MULTIFUEL)	200
SWR/SF/200/2	670 mm STRAIGHT PIPE s.w. (MULTIFUEL)	200
SWR/SF/200/3	330mm STRAIGHT PIPE s.w. (MULTIFUEL)	200
SWR/SF/200/30	590-420 ADJ STRAIGHT PIPE s.w. (MULTIFUEL)	200

STAINLESS STEEL BENDS



SWR/SF/153/11A	30° Bend S.W. (MULTIFUEL)	153
SWR/SF/180/11A	30° Bend S.W. (MULTIFUEL)	180
SWR/SF/200/11A	30° Bend S.W. (MULTIFUEL)	200
SWR/SF/153/4	45° BEND S.W. (MULTIFUEL)	153
SWR/SF/180/4	45° BEND S.W. (MULTIFUEL)	180
SWR/SF/200/4	45° BEND S.W. (MULTIFUEL)	200
SWR/SF/153/5	90° BEND (OIL & GAS ONLY) S.W.	153
SWR/SF/180/5	90° BEND (OIL & GAS ONLY) S.W.	180
SWR/SF/200/5	90° BEND (OIL & GAS ONLY) S.W.	200
SWR/SF/153/6	90° BEND C/W DOOR (OIL & GAS ONLY)s.w.	153
SWR/SF/180/6	90° BEND C/W DOOR (OIL & GAS ONLY)s.w.	180
SWR/SF/200/6	90° BEND C/W DOOR (OIL & GAS ONLY)s.w.	200

STAINLESS STEEL TEE-PIECE & PLUG



SWR/SF/153/7	90° TEE PIECE (NO PLUG) (SOLID FUEL)	153
SWR/SF/180/7	90° TEE PIECE (NO PLUG) (SOLID FUEL)	180
SWR/SF/200/7	90° TEE PIECE (NO PLUG) (SOLID FUEL)	200
SWR/SF/153/8	45° TEE PIECE (NO PLUG) (SOLID FUEL)	153
SWR/SF/180/8	45° TEE PIECE (NO PLUG) (SOLID FUEL)	180
SWR/SF/200/8	45° TEE PIECE (NO PLUG) (SOLID FUEL)	200
SWR/SF/153/9	TEE CAP PLUG (SOLID FUEL)	153
SWR/SF/180/9	TEE CAP PLUG (SOLID FUEL)	180
SWR/SF/200/9	TEE CAP PLUG (SOLID FUEL)	200

STAINLESS STEEL ROSETTE 45° & 90° 4" LEAF ROSETTE

ROSETTES AVAILABLE IN A VARIETY OF ANGLES & SIZES ON REQUEST

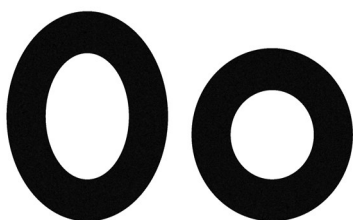

SWR/100/45/ROS	45° ROSETTE FOR 100mm s.w (4" LEAF)	100
SWR/100/90/ROS	90° ROSETTE FOR 100mm s.w (4" LEAF)	100
SWR/153/45/ROS	45° ROSETTE FOR 153mm s.w (4" LEAF)	153
SWR/153/90/ ROS	90° ROSETTE FOR 150mm s.w (4" LEAF)	153
SWR/180/45/ROS	45° ROSETTE FOR 180mm s.w (4" LEAF)	180
SWR/180/90/ROS	90° ROSETTE FOR 180mm s.w (4" LEAF)	180

STAINLESS STEEL STANDARD & OFFSET CLAY ADAPTOR



SWR/SF/125/29-INT	INT. CLAY ADAPTOR (153 - 125mm) S.W. (MULTIFUEL)	153/125
SWR/SF/153/28-INT	INT. CLAY ADAPTOR (180 - 125mm) S.W. (MULTIFUEL)	180/125
SWR/SF/153/33-INT	INT. CLAY ADAPTOR (180 - 153mm) S.W. (MULTIFUEL)	180/153
SWR/SF/125/17-INT	INT. CLAY ADAPTOR (200 - 125mm) S.W. (MULTIFUEL)	200/125
SWR/SF/153/17-INT	INT. CLAY ADAPTOR (200 - 153mm) S.W. (MULTIFUEL)	200/153
SWR/SF/125/18-INT	INT. CLAY ADAPTOR (225 - 125mm) S.W. (MULTIFUEL)	225/125
SWR/SF/153/18-INT	INT. CLAY ADAPTOR (225 - 153mm) S.W. (MULTIFUEL)	225/153
SWR/SF/180/17-INT	INT. CLAY ADAPTOR (200 - 180mm) S.W. (MULTIFUEL)	200/180
SWR/SF/180/18-INT	INT. CLAY ADAPTOR (225 - 180mm) S.W. (MULTIFUEL)	225/180
SWR/SF/125/26-INT	INT. CLAY ADAPTOR OFFSETS (200 - 125mm)	200/125
SWR/SF/153/26-INT	INT. CLAY ADAPTOR OFFSETS (200 - 153mm)	200/153
SWR/SF/125/27-INT	INT. CLAY ADAPTOR OFFSETS (225 - 125mm)	225/125
SWR/SF/153/27-INT	INT. CLAY ADAPTOR OFFSETS (225 - 153mm)	225/153

STAINLESS STEEL EXTERNAL CLAY ADAPTOR



SWR/SF/125/17-EXT	EXT. CLAY ADAPTOR (200 - 125mm) S.W. (MULTIFUEL)	200/125
SWR/SF/125/18-EXT	EXT. CLAY ADAPTOR (225 - 125mm) S.W. (MULTIFUEL)	200/125
SWR/SF/125/26-EXT	EXT. CLAY ADAPTOR (200 - 125mm) S.W. (MULTIFUEL)	225/125
SWR/SF/125/27-EXT	EXT. CLAY ADAPTOR (225 - 125mm) S.W. (MULTIFUEL)	225/125
SWR/SF/153/17-EXT	EXT. CLAY ADAPTOR (200 - 153mm) S.W. (MULTIFUEL)	200/153
SWR/SF/153/18-EXT	EXT. CLAY ADAPTOR (225 - 153mm) S.W. (MULTIFUEL)	200/153
SWR/SF/153/26-EXT	EXT. CLAY ADAPTOR (200 - 153mm) S.W. (MULTIFUEL)	225/153
SWR/SF/153/27-EXT	EXT. CLAY ADAPTOR (225 - 153mm) S.W. (MULTIFUEL)	225/153
SWR/SF/180/17-EXT	EXT. CLAY ADAPTOR (200 - 180mm) S.W. (MULTIFUEL)	200/180
SWR/SF/180/18-EXT	EXT. CLAY ADAPTOR (225 - 180mm) S.W. (MULTIFUEL)	225/180

STAINLESS STEEL STORM COLLAR

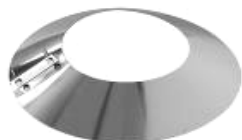

SWR/SF/125/23	STORM COLLAR S.W. (MULTIFUEL)	125
SWR/SF/153/23	STORM COLLAR S.W. (MULTIFUEL)	153
SWR/SF/180/23	STORM COLLAR S.W. (MULTIFUEL)	180
SWR/SF/200/23	STORM COLLAR S.W. (MULTIFUEL)	200

STAINLESS STEEL WALL BRACKET & EXTENSION



SWR/153/11	WALL BRACKET S.W.	153
SWR/180/11	WALL BRACKET S.W.	180
SWR/200/11	WALL BRACKET S.W.	200
ADJ/BRKT/153/S	ADJUSTABLE WALL BRACKET	153
ADJ/BRKT/180/S	ADJUSTABLE WALL BRACKET	180
ADJ/BRKT/200/S	ADJUSTABLE WALL BRACKET	200

STAINLESS STEEL HAT



SWR/SF/153/10	CHIMNEY HAT S.W. (MULTIFUEL)	153
SWR/SF/180/10	CHIMNEY HAT S.W. (MULTIFUEL)	180
SWR/SF/200/10	CHIMNEY HAT S.W. (MULTIFUEL)	200

STAINLESS STEEL ADJUSTABLE ELBOW 0°-90°



SWR/SF/125/32	Adjustable elbow 0° to 90° 125mm Diameter	130
SWR/SF/153/32	Adjustable elbow 0° to 90° 153mm Diameter	153
SWR/SF/180/32	Adjustable elbow 0° to 90° 180mm Diameter	180
SWR/SF/200/32	Adjustable elbow 0° to 90° 153mm Diameter	200

STAINLESS STEEL HINGED SPINNING COWL



SPINNING COWL/HINGED	HINGED SPINNING COWL 125mm - 250mm	125/250
----------------------	------------------------------------	---------

CLAYPOT BIRD CAGES



SWR/SF/C-P/HAT-TERRA	COWL WITH BIRD CAGE (180-225) TERRACOTTA	180/225
SWR/SF/C-P/HAT-SS	COWL WITH BIRD CAGE (180-225) STAINLESS	180/225
SWR/SF/C-P/HAT-BLACK	COWL WITH BIRD CAGE (180-225) BLACK	180/225

RYTONS
BUILDING PRODUCTS
INNOVATION IN VENTILATION

CAVITY WALL AIRCORE
CAVITY LINER SET BOILER, STOVE AND FIRE VENTILATORS
PASSIVE VENT SET WITH CONTROLLABLE PANEL



PREMIER LENGTHS S/S

BU 1.0mm 316L S/S



SWR/SF/125/C-1	1000mm STRAIGHT PIPE S.S. (MULTIFUEL)	125
SWR/SF/125/C-2	500 mm STRAIGHT PIPE S.S (MULTIFUEL)	125
SWR/SF/125/C-3	250mm STRAIGHT PIPE S.S (MULTIFUEL)	125
SWR/SF/125/C-30	250-400 ADJ. STRAIGHT PIPE S.S (MULTIFUEL)	125
SWR/SF/150/C-1	1000mm STRAIGHT PIPE S.S (MULTIFUEL)	150
SWR/SF/150/C-2	5000 mm STRAIGHT PIPE S.S (MULTIFUEL)	150
SWR/SF/150/C-3	250mm STRAIGHT PIPE S.S. (MULTIFUEL)	150
SWR/SF/150/C-30	250-400 ADJ. STRAIGHT PIPE S.S. (MULTIFUEL)	150

PREMIER BENDS S/S

BU 1.0mm 316L S/S



SWR/SF/125/C-11A	30° BEND MULTIFUEL	125
SWR/SF/125/C-33	15° BEND MULTIFUEL	125
SWR/SF/125/C-4	45° BEND MULTIFUEL	125
SWR/SF/150/C-11A	30° BEND MULTIFUEL	150
SWR/SF/150/C-33	15° BEND MULTIFUEL	150
SWR/SF/150/C-4	45° BEND MULTIFUEL	150

PREMIER TEE PIECE & PLUG S/S

BU 1.0mm 316L S/S



SWR/SF/125/C-7	90° TEE PIECE MULTIFUEL	125
SWR/SF/150/C-7	90° TEE PIECE MULTIFUEL	153
SWR/SF/125/C-9	TEE CAP PLUG MULTIFUEL	125
SWR/SF/150/C-9	TEE CAP PLUG MULTIFUEL	153

PREMIER OFFSET BENDS S/S

BU 1.0mm 316L S/S

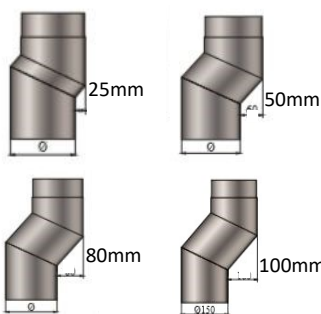

SWR/SF/125/C-OS-100	100mm OFFSET BEND 125mm	125
SWR/SF/125/C-OS-25	25mm OFFSET BEND 125mm	125
SWR/SF/125/C-OS-50	50mm OFFSET BEND 125mm	125
SWR/SF/125/C-OS-80	80mm OFFSET BEND 125mm	125
SWR/SF/150/C-OS-100	100mm OFFSET BEND 150mm	150
SWR/SF/150/C-OS-25	25mm OFFSET BEND 150mm	150
SWR/SF/150/C-OS-50	50mm OFFSET BEND 150mm	150
SWR/SF/150/C-OS-80	80mm OFFSET BEND 150mm	150

PREMIER COUPLING & ADAPTORS S/S

BU 1.0mm 316L S/S



SWR/SF/125/C-34	MALE-MALE COUPLING S.W.	125
SWR/SF/125/C-35	FEMALE-FEMALE COUPLING S.W.	125
SWR/SF/125/C-36	INCREASER 125mm-150mm S.W.	125
SWR/SF/125/C-37	FIT OVER CLAY ADAPTER SPIGOT & INTO S.W. 125m	125
SWR/SF/125/C-38	TO FIT OVER CLAY ADAPTER SPIGOT & INTO 125mm	125
SWR/SF/150/C-34	MALE-MALE COUPLING S.W.	150
SWR/SF/150/C-35	FEMALE-FEMALE COUPLING S.W.	150
SWR/SF/150/C-37	TO FIT OVER BU CLAY ADAPTER SPIGOT & INTO 150mm	150
SWR/SF/150/C-38	TO FIT OVER CLAY ADAPTER SPIGOT & INTO 150mm	150

* PRODUCT DESIGNATION APPLICABLE TO INDIVIDUAL ITEMS, PLEASE CHECK PRODUCT.

PART No.

DESCRIPTION

MM

PREMIER CLAY ADAPTORS S/S

BU 1.0mm 316L S/S



SWR/SF/125/C-17-INT

INT. CLAY ADAPTER 200-125mm

125

SWR/SF/125/C-26-INT

INT. CLAY ADAPTER OFFSET 200-125

125

SWR/SF/150/C-17-INT

INT. CLAY ADAPTER 200-150mm

150

SWR/SF/150/C-26-INT

INT. CLAY ADAPTER OFFSET 200-150

150

PREMIER ADJUSTABLE BEND KITS S/S

(SOLD AS ONE UNIT ONLY)



FL/125/30-KIT

30° ADJ. FLEXI BEND KIT 125mm

125

FL/125/45-KIT

45° ADJ. FLEXI BEND KIT 150mm

125

FL/125/90-KIT

90° ADJ. FLEXI BEND KIT 125mm

125

FL/150/30-KIT

30° ADJ. FLEXI BEND KIT 150mm

150

FL/150/45-KIT

45° ADJ. FLEXI BEND KIT 150mm

150

FL/150/90-KIT

90° ADJ. FLEXI OFFSET BEND KIT 150mm

150

PREMIER CLAY ADAPTOR SLEEVE S/S

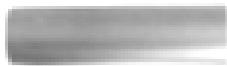

SWR/SF/125/C-SLEEVE

1000 mm STRAIGHT PIPE S.W. TO SLEEVE OVER CLAY ADAPTER SPIGOT 125mm

125

SWR/SF/150/C-SLEEVE

1000 mm STRAIGHT PIPE S.W. TO SLEEVE OVER CLAY ADAPTER SPIGOT 150mm

150

PREMIER WALL BRACKET S/S

BU 1.0mm 316 S/S



SWR/SF/125/C-11

WALL BRACKET FOR 125mm

125

SWR/SF/150/C-11

WALL BRACKET FOR 150mm

150



H003
DRY STOVE INSTALLER TRAINING

H004
BOILER STOVE INSTALLER TRAINING

H006
TWINWALL INSTALLER TRAINING



SPECIALIST MANUFACTURER
ORIEL FLUES
www.orielflues.com





* PRODUCT DESIGNATION

SINGLE WALL CONNECTING FLUE PIPES (EN1856-2 T600-N1-W-Vm-L50100-G(XX)NM)

STAINLESS STEEL LENGTHS OIL & GAS



SWR/OG/125/1	1000mm STRAIGHT PIPE S.W. (OIL & GAS)	125
SWR/OG/125/2	500mm STRAIGHT PIPE S.W. (OIL & GAS)	125
SWR/OG/125/3	330mm STRAIGHT PIPE S.W. (OIL & GAS)	125
SWR/OG/153/1	1000mm STRAIGHT PIPE S.W. (OIL & GAS)	153
SWR/OG/153/2	500mm STRAIGHT PIPE S.W. (OIL & GAS)	153
SWR/OG/153/3	330mm STRAIGHT PIPE S.W. (OIL & GAS)	153
SWR/OG/180/1	1000mm STRAIGHT PIPE S.W. (OIL & GAS)	180
SWR/OG/180/2	500mm STRAIGHT PIPE S.W. (OIL & GAS)	180
SWR/OG/180/3	330mm STRAIGHT PIPE S.W. (OIL & GAS)	180
SWR/OG/200/1	1000mm STRAIGHT PIPE S.W. (OIL & GAS)	200
SWR/OG/200/2	500mm STRAIGHT PIPE S.W. (OIL & GAS)	200
SWR/OG/200/3	330mm STRAIGHT PIPE S.W. (OIL & GAS)	200

STAINLESS STEEL BENDS OIL & GAS



SWR/OG/125/4	90° BEND S.W. (OIL & GAS)	125
SWR/OG/153/4	90° BEND S.W. (OIL & GAS)	153
SWR/OG/180/4	90° BEND S.W. (OIL & GAS)	180
SWR/OG/200/4	90° BEND S.W. (OIL & GAS)	200
SWR/OG/125/5	45° BEND S.W. (OIL & GAS)	125
SWR/OG/153/5	45° BEND S.W. (OIL & GAS)	153
SWR/OG/180/5	45° BEND S.W. (OIL & GAS)	180
SWR/OG/200/5	45° BEND S.W. (OIL & GAS)	200
SWR/OG/125/6	30° BEND S.W. (OIL & GAS)	125
SWR/OG/153/6	30° BEND S.W. (OIL & GAS)	153
SWR/OG/180/6	30° BEND S.W. (OIL & GAS)	180
SWR/OG/200/6	30° BEND S.W. (OIL & GAS)	200

STAINLESS STEEL OIL & GAS TEE PIECE & PLUG



SWR/OG/125/7	90° TEE PIECE (NO PLUG) S.W. (OIL & GAS)	125
SWR/OG/153/7	90° TEE PIECE (NO PLUG) S.W. (OIL & GAS)	153
SWR/OG/180/7	90° TEE PIECE (NO PLUG) S.W. (OIL & GAS)	180
SWR/OG/200/7	90° TEE PIECE (NO PLUG) S.W. (OIL & GAS)	200
SWR/OG/125/8	45° TEE PIECE (NO PLUG) S.W. (OIL & GAS)	125
SWR/OG/153/8	45° TEE PIECE (NO PLUG) S.W. (OIL & GAS)	153
SWR/OG/180/8	45° TEE PIECE (NO PLUG) S.W. (OIL & GAS)	180
SWR/OG/200/8	45° TEE PIECE (NO PLUG) S.W. (OIL & GAS)	200
SWR/OG/125/9	TEE CAP PLUG S.W. (OIL & GAS)	125
SWR/OG/153/9	TEE CAP PLUG S.W. (OIL & GAS)	153
SWR/OG/180/9	TEE CAP PLUG S.W. (OIL & GAS)	180
SWR/OG/200/9	TEE CAP PLUG S.W. (OIL & GAS)	200

STAINLESS STEEL WALL BRACKET & EXTENSION OIL & GAS



SWR/125/11	WALL BRACKET S.W.	125
SWR/153/11	WALL BRACKET S.W.	153
SWR/180/11	WALL BRACKET S.W.	180
ADJ/BRKT/125/S	ADJUSTABLE WALL BRACKET	125
ADJ/BRKT/153/S	ADJUSTABLE WALL BRACKET	153
ADJ/BRKT/180/S	ADJUSTABLE WALL BRACKET	180

STAINLESS STEEL HAT OIL & GAS



SWR/OG/125/10	CHIMNEY HAT S.W. (OIL & GAS)	125
SWR/OG/153/10	CHIMNEY HAT S.W. (OIL & GAS)	153
SWR/OG/180/10	CHIMNEY HAT S.W. (OIL & GAS)	180
SWR/OG/200/10	CHIMNEY HAT S.W. (OIL & GAS)	200

MULTI ROOF FLASHING



TWR/MF/RS/33	MULTI FLASHING (76mm to 203mm)	-
TWR/MF/RS/35	MULTI FLASHING (88mm to 171mm)	-
TWR/MF/RS/36	MULTI FLASHING (165mm to 304mm)	-

STAINLESS STEEL OIL & GAS CLAY ADAPTOR KIT



SWR/SF/125/25	CLAY ADAPTOR KIT (OIL & GAS)	125
SWR/SF/153/25	CLAY ADAPTOR KIT (OIL & GAS)	153
SWR/SF/180/25	CLAY ADAPTOR KIT (OIL & GAS)	180



P. O. A.

Ei208 Battery CO Alarm

- Battery powered by a sealed in lithium cell
- Built in AudioLINK data extraction technology
- 10 year life
- Easy to fit twist on base and multi-fixings
- Proven electrochemical sensor



BS EN 50291-1:2010
BS EN 50291-2:2010



Ei208 Battery Carbon Monoxide Alarm

The Ei208 Carbon Monoxide Alarm is a standalone battery unit, powered by 10 year life sealed in Lithium cell.

This means you won't need to replace the battery at any point in the life of the alarm and also that the battery can not be removed ensuring continued protection.

As with all Aico Carbon Monoxide alarms – the Ei208 has AudioLINK Data Extraction Technology built in. Simply download the free AudioLINK App to your compatible tablet or smartphone to be extract a simple and easy to read 'Alarm Status' report from the alarm. This report contains data such as alarm activations, carbon monoxide levels reached, background levels of Carbon Monoxide and battery life.

* PRODUCT DESIGNATION APPLICABLE TO INDIVIDUAL ITEMS, PLEASE CHECK PRODUCT.

PART No.

DESCRIPTION

Ø

ORIFLEX SPOOL OIL & GAS

OIL & GAS



FL/OG/100/1	50 METRE SPOOL	100
FL/OG/125/1	50 METRE SPOOL	125
FL/OG/150/1	50 METRE SPOOL	150
FL/OG/180/1	30 METRE SPOOL	180
FL/OG/200/1	30 METRE SPOOL	200

ORIFLEX OIL & GAS 6 METRE & 9 METRE COILS

OIL & GAS



FL/OG/100/9	6 METRE COIL	100
FL/OG/125/9	6 METRE COIL	125
FL/OG/150/9	6 METRE COIL	150
FL/OG/180/9	6 METRE COIL	180
FL/OG/200/9	6 METRE COIL	200
FL/OG/100/10	9 METRE COIL	100
FL/OG/125/10	9 METRE COIL	125
FL/OG/150/10	9 METRE COIL	150
FL/OG/180/10	9 METRE COIL	180
FL/OG/200/10	9 METRE COIL	200

ORIFLEX LINEAR LENGTHS OIL & GAS

OIL & GAS



FL/OG/100/3	LINEAR METRE PACK CUT	100
FL/OG/125/3	LINEAR METRE PACK CUT	125
FL/OG/150/3	LINEAR METRE PACK CUT	150
FL/OG/180/3	LINEAR METRE PACK CUT	180
FL/OG/200/3	LINEAR METRE PACK CUT	200

 **ORIFLEX**

THE WORLDS TOUGHEST FLEXI FLUE

* PRODUCT DESIGNATION

En:1856-1.T450-N1-D-VM-L50080-G(3xd)

ORIFLEX SPOOL 904L GRADE

SOLID FUEL



FL/SF/100/1-904L-ORIFLEX	50 METRE SPOOL 904L ORIFLEX	100
FL/SF/125/1-904L-ORIFLEX	36 METRE SPOOL 904L ORIFLEX	125
FL/SF/150/1-904L-ORIFLEX	36 METRE SPOOL 904L ORIFLEX	150
FL/SF/180/1-904L-ORIFLEX	30 METRE SPOOL 904L ORIFLEX	180
FL/SF/200/1-904L-ORIFLEX	30 METRE SPOOL 904L ORIFLEX	200

ORIFLEX 904L GRADE 6 METRE & 9 METRE COILS

SOLID FUEL



FL/SF/100/9-904-ORIFLEX	6 METRE COIL 904L ORIFLEX	100
FL/SF/125/9-904-ORIFLEX	6 METRE COIL 904L ORIFLEX	125
FL/SF/150/9-904-ORIFLEX	6 METRE COIL 904L ORIFLEX	150
FL/SF/180/9-904-ORIFLEX	6 METRE COIL 904L ORIFLEX	180
FL/SF/200/9-904-ORIFLEX	6 METRE COIL 904L ORIFLEX	200
FL/SF/100/10-904-ORIFLEX	9 METRE COIL 904L ORIFLEX	100
FL/SF/125/10-904-ORIFLEX	9 METRE COIL 904L ORIFLEX	125
FL/SF/150/10-904-ORIFLEX	9 METRE COIL 904L ORIFLEX	150
FL/SF/180/10-904-ORIFLEX	9 METRE COIL 904L ORIFLEX	180
FL/SF/200/10-904-ORIFLEX	9 METRE COIL 904L ORIFLEX	200

ORIFLEX LINEAR 904L GRADE

SOLID FUEL



FL/SF/100/3-904-ORIFLEX	LINEAR METRE 904L ORIFLEX	100
FL/SF/125/3-904-ORIFLEX	LINEAR METRE 904L ORIFLEX	125
FL/SF/150/3-904-ORIFLEX	LINEAR METRE 904L ORIFLEX	150
FL/SF/180/3-904-ORIFLEX	LINEAR METRE 904L ORIFLEX	180
FL/SF/200/3-904-ORIFLEX	LINEAR METRE 904L ORIFLEX	200

ORIFLEX
 THE WORLDS TOUGHEST FLEXI FLUE

ORIFLEX SPOOL 316L GRADE

SOLID FUEL



FL/SF/100/1-ORIFLEX	50 METRE SPOOL 316L ORIFLEX	100
FL/SF/125/1-ORIFLEX	36 METRE SPOOL 316L ORIFLEX	125
FL/SF/150/1-ORIFLEX	36 METRE SPOOL 316L ORIFLEX	150
FL/SF/180/1-ORIFLEX	30 METRE SPOOL 316L ORIFLEX	180
FL/SF/200/1-ORIFLEX	30 METRE SPOOL 316L ORIFLEX	200

ORIFLEX 316L GRADE 6 METRE & 9 METRE COILS

SOLID FUEL



FL/SF/100/9-ORIFLEX	6 METRE COIL 316L ORIFLEX	100
FL/SF/125/9-ORIFLEX	6 METRE COIL 316L ORIFLEX	125
FL/SF/150/9-ORIFLEX	6 METRE COIL 316L ORIFLEX	150
FL/SF/180/9-ORIFLEX	6 METRE COIL 316L ORIFLEX	180
FL/SF/200/9-ORIFLEX	6 METRE COIL 316L ORIFLEX	200
FL/SF/100/10-ORIFLEX	9 METRE COIL 316L ORIFLEX	100
FL/SF/125/10-ORIFLEX	9 METRE COIL 316L ORIFLEX	125
FL/SF/150/10-ORIFLEX	9 METRE COIL 316L ORIFLEX	150
FL/SF/180/10-ORIFLEX	9 METRE COIL 316L ORIFLEX	180
FL/SF/200/10-ORIFLEX	9 METRE COIL 316L ORIFLEX	200

ORIFLEX LINEAR LENGTHS 316L GRADE

SOLID FUEL



FL/SF/100/3-ORIFLEX	LINEAR METRE 316L ORIFLEX	100
FL/SF/125/3-ORIFLEX	LINEAR METRE 316L ORIFLEX	125
FL/SF/150/3-ORIFLEX	LINEAR METRE 316L ORIFLEX	150
FL/SF/180/3-ORIFLEX	LINEAR METRE 316L ORIFLEX	180
FL/SF/200/3-ORIFLEX	LINEAR METRE 316L ORIFLEX	200

ORIFLEX

THE WORLDS TOUGHEST FLEXI FLUE

* PRODUCT DESIGNATION APPLICABLE TO INDIVIDUAL ITEMS, PLEASE CHECK PRODUCT.

FLEXI CLAMP COLLAR SOLID FUEL / OIL & GAS



PART No.	DESCRIPTION	Ø
FL/100/5	CLAMP COLLAR FOR FLEXI FLUE	100
FL/125/5	CLAMP COLLAR FOR FLEXI FLUE	125
FL/150/5	CLAMP COLLAR FOR FLEXI FLUE	150
FL/180/5	CLAMP COLLAR FOR FLEXI FLUE	180
FL/200/5	CLAMP COLLAR FOR FLEXI FLUE	200

FLEXI ADAPTORS SOLID FUEL / OIL & GAS



FL/80/14-A	JOINER/INC. FOR 80mm/100mm C/W INSERT	80/100
FL/100/8	FLUE JOINER FOR FLEXI FLUE	100
FL/125/8	FLUE JOINER FOR FLEXI FLUE	125
FL/150/8	FLUE JOINER FOR FLEXI FLUE	150
FL/180/8	FLUE JOINER FOR FLEXI FLUE	180
FL/200/8	FLUE JOINER FOR FLEXI FLUE	200
FL/100/8-A	FLUE JOINER WITH INSERT	100
FL/125/8-A	FLUE JOINER WITH INSERT	125
FL/150/8-A	FLUE JOINER WITH INSERT	150
FL/180/8-A	FLUE JOINER WITH INSERT	180
FL/200/8-A	FLUE JOINER WITH INSERT	200
FL/100/14-A	JOINER/INC. FOR 100mm/125mm C/W INSERT	100/125
FL/125/14-A	JOINER/INC. FOR 125mm/150mm C/W INSERT	125/150

FLEXI HATS SOLID FUEL / OIL & GAS



FL/100/7	CHIMNEY HAT FOR FLEXI FLUE	100
FL/125/7	CHIMNEY HAT FOR FLEXI FLUE	125
FL/150/7	CHIMNEY HAT FOR FLEXI FLUE	150
FL/180/7	CHIMNEY HAT FOR FLEXI FLUE	180
FL/200/7	CHIMNEY HAT FOR FLEXI FLUE	200
FL/100/25	ANTI DOWN DRAUGHT CHIMNEY HAT FOR FLEXI FLUE	100
FL/125/25	ANTI DOWN DRAUGHT CHIMNEY HAT FOR FLEXI FLUE	125
FL/150/25	ANTI DOWN DRAUGHT CHIMNEY HAT FOR FLEXI FLUE	150
FL/125/POT-COWL	POT HANGAR COWL 5" FLEXI C/W MESH GUARD S/S	125
FL/150/POT-COWL	POT HANGAR COWL 6" FLEXI C/W MESH GUARD S/S	150
FL/125/POT-COWL-TER	POT HANGAR COWL 5" FLEXI C/W MESH GUARD TERA	125
FL/150/POT-COWL-TER	POT HANGAR COWL 6" FLEXI C/W MESH GUARD TERA	150
SWR/SF/C-P/HAT-TERR	COWL WITH BIRD CAGE (180-225) TERRACOTTA	180-225
SWR/SF/C-P/HAT-SS	COWL WITH BIRD CAGE (180-225) STAINLESS	180/225
SWR/SF/C-P/HAT-BLACK	COWL WITH BIRD CAGE (180-225) BLACK	180/225

TERMINAL FOR OIL & GAS ONLY

SWR/OG/200-300/GAS-COWL-TERMINAL 5" GAS COWL C/W STRAPS TO SUIT 8-10' CLAY POT 200-300



* PRODUCT DESIGNATION Enr1856-1.T450-N1-D-VM-L50080-G(3xd)



* PRODUCT DESIGNATION APPLICABLE TO INDIVIDUAL ITEMS, PLEASE CHECK PRODUCT.

PART No.

DESCRIPTION

Ø

FLEXI POT HANGER SOLID FUEL / OIL & GAS



FL/125/12	POT HANGER BASE (NOT PAINTED)	125
FL/150/12	POT HANGER BASE (NOT PAINTED)	150

FLEXI CLOSURE COLLAR SOLID FUEL / OIL & GAS



FL/100/CLOS-COLLAR	CLOSURE COLLAR FOR FLEXI FLUE	100
FL/125/CLOS-COLLAR	CLOSURE COLLAR FOR FLEXI FLUE	125
FL/150/CLOS-COLLAR	CLOSURE COLLAR FOR FLEXI FLUE	150
FL/180/CLOS-COLLAR	CLOSURE COLLAR FOR FLEXI FLUE	180
FL/200/CLOS-COLLAR	CLOSURE COLLAR FOR FLEXI FLUE	200

FLEXI PULLING CONE SOLID FUEL / OIL & GAS



image not available

FL/100/CONE	TOWING CONE FOR FLEXI FLUE	100
FL/125/CONE	TOWING CONE FOR FLEXI FLUE	125
FL/150/CONE	TOWING CONE FOR FLEXI FLUE	150
FL/180/CONE	TOWING CONE FOR FLEXI FLUE	180
FL/200/CONE	TOWING CONE FOR FLEXI FLUE	200

VERMICULITE SOLID FUEL / OIL & GAS



VERMICULITE V4	VERMICULITE V4 PACKED IN 100 LITRES BAGS. TEN BAGS PER 1m CUBED	-
CLAY/AGGREGATE	LIGHT EXPANDED CLAY AGGREGATE PACKED IN 50 LITRES BAGS.	-

FLEXI CENTERING PLATE SOLID FUEL / OIL & GAS

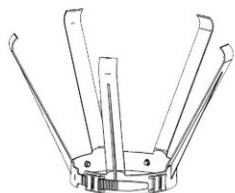

FL/100/CTR-PLATE	CENTERING PLATE FOR FLEXI FLUE	100
FL/125/CTR-PLATE	CENTERING PLATE FOR FLEXI FLUE	125
FL/150/CTR-PLATE	CENTERING PLATE FOR FLEXI FLUE	150
FL/180/CTR-PLATE	CENTERING PLATE FOR FLEXI FLUE	180
FL/200/CTR-PLATE	CENTERING PLATE FOR FLEXI FLUE	200

STOVE BRIGHT- HIGH TEMPERATURE PAINT



TWR/MF/AEROSOL/BOX	CHARCOAL PAINT 400ml (BOX OF 12)
TWR/MF/AEROSOL/CAN	CHARCOAL PAINT 400ml
TWR/MF/PAINT/18.9L	CHARCOAL PAINT - 18.9 LITRE DRUM

* PRODUCT DESIGNATION

Enr1856-1.T450-N1-D-VM-L50080-G(3xd)

RELINING OF AN EXISTING CHIMNEY WITH FLEXI FLUE & SINGLE WALL TEE SYSTEM WITH A DOUBLE INSULATED SOOT DOOR

CHIMNEY HAT FOR FLEXI FLUE
CLAMP COLLAR FOR FLEXI FLUE
FLEXI FLUE LINER

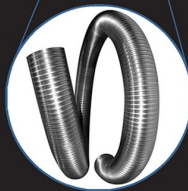

VERMICULITE INSULATION AROUND FLEXI FLUE
CLOSURE PLATE FOR FLEXI FLUE LINED CHIMNEY
45° SINGLE WALL TEE



DOUBLE INSULATED SOOT DOOR
WALL SLEEVE WITH NON COMBUSTIBLE FIRE ROPE SEAL
VITREOUS ENAMEL 45° BEND WITH CLEANING DOOR
VITREOUS ENAMEL STRAIGHT PIPE

INSTALLATION OF AN INSET STOVE WITH THE RELINING OF AN EXISTING CHIMNEY WITH FLEXI FLUE AND SINGLE WALL FLUE

CHIMNEY HAT FOR FLEXI FLUE
CLAMP COLLAR FOR FLEXI FLUE



FLEXI FLUE LINER
VERMICULITE INSULATION AROUND FLEXI FLUE

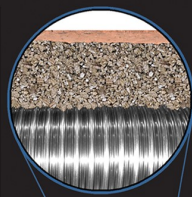

FLUE JOINER FOR FLEXI FLUE



CLOSURE PLATE FOR FLEXI FLUE LINED CHIMNEY
SINGLE WALL STAINLESS STEEL FLUE PIPE

INTERNAL TWIN WALL INSULATED FLUE SYSTEM FOR SINGLE AND MULTISTOREY BUILDINGS

TWIN WALL CHIMNEY CAP
TWIN WALL STRAIGHT PIPE
ROOF LEAD FLASHING WITH STORM COLLAR



SUPPORT COLLAR FOR JOIST
PROTECTIVE MESH IN ATTIC
FIRESTOP WITH TWIN WALL ADAPTOR AND SUPPORT COLLAR

VENTILATED ENCLOSURE WITH TWIN WALL INSULATED FLUE
INSPECTION DOORS
FIRESTOP WITH TWIN WALL ADAPTOR AND SUPPORT COLLAR

TWIN WALL ADAPTOR WITH COLLAR
VITREOUS ENAMEL STRAIGHT PIPE



EXTERNAL TWIN WALL INSULATED FLUE SYSTEM WITH EASY ACCESS CLEANING DOOR

TWIN WALL CHIMNEY CAP
TWIN WALL STRAIGHT PIPE
WALL BRACKET



TWIN WALL SEGMENTED BEND
WALL BRACKET
BASE WALL SUPPORT



TWIN WALL 45° TEE (AVAILABLE 45° OR 90° TEE)
CLEANING DOOR
WALL SLEEVE WITH NON COMBUSTIBLE FIRE ROPE

TWIN WALL ADAPTOR WITH COLLAR
VITREOUS ENAMEL 45° BEND WITH CLEANING DOOR
VITREOUS ENAMEL STRAIGHT PIPE

SAFEFLUE ORIEFLUE

Oriel Flue Products are Tested to BS EN 1856-1 & BS EN 1856-2 and are CE approved. All Flue systems must be installed, by competent and qualified technicians. All appliances should be installed in compliance with the manufacturer's instructions. All installations should always comply with the current revision of Section J of the department of the Environment, Heritage and Local Governments Building Regulations. Oriel Flues do not accept responsibility for damages as a result of inadequate installation practices or in cases where the flue systems and appliances are not installed in accordance with the prerequisite standards. This document is the property of Oriel Flues Ltd. Do not reproduce edit or copy without the express written consent of Oriel Flues Ltd.

© 2010 Oriel Flues Ltd.





NOTES

Prices

All pricing shown in this brochure is Nett Dealer Price (NDP) and is exclusive of VAT and transport costs

STERLING PAYMENTS Invoices are issued in euro currency. The customer is liable for any exchange difference which may arise when paying in sterling.

TRANSPORT

All shipments dispatched by Oriel with a Nett Value of €300 (Excluding VAT) or less will be subject to a Courier charge.

SHORTAGES

Oriel Flues must be notified in writing of all shortages on deliveries within 5 days of Delivery Docket Date.

DAMAGES

All goods when delivered must be inspected for damages. All damages must be reported to Oriel Flues Ltd and recorded for on couriers delivery docket. Oriel will not be responsible after delivery has been signed for.

GOODS RETURNED

All goods returned to Oriel Flues are subjected to a 15% restocking charge. Goods when returned by customer and inspected for damages will be Credited to Customers' account. Quality of the returns is not the responsibility of Oriel Flues.

SPECIALS

Specials ordered by customer and manufactured to customers' specification cannot be returned.



ARDEE ENTERPRISE CENTRE, ARDEE, CO. LOUTH, IRELAND, A92XOV1 TEL: 0035341 685 6924

EMAIL: SALES@ORIELFLUES.COM WWW.ORIELFLUES.COM

